

Seră

Instrucțiuni de instalare

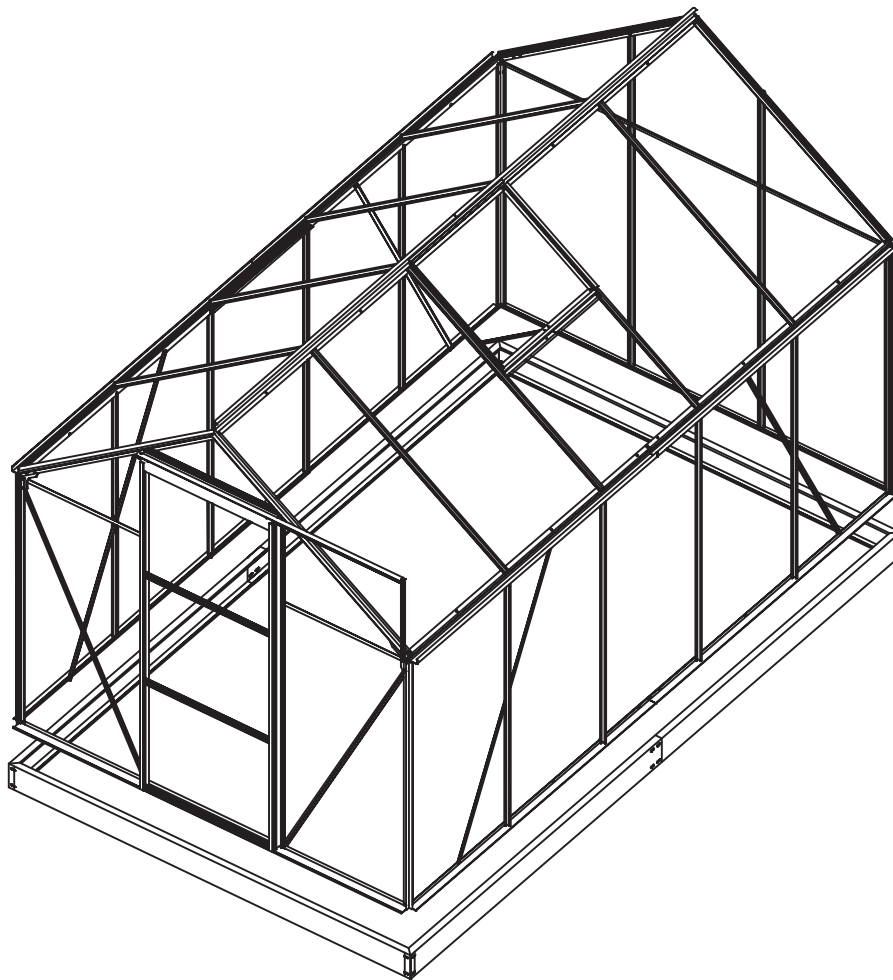

1900 mm (D) x 3700 mm (Ș) x 1950 mm (V)

IMPORTANT

Înainte să începeți să montați această seră, trebuie să citiți cu atenție aceste instrucțiuni. Asigurați-vă că găsiți toate piesele în cutie, tipul și cantitatea corectă, așa cum este listat pe fiecare pagină în mod corespunzător.

Vă rugăm să urmați instrucțiunile din acest manual.

Strângeți piesele individuale ale serei, numai după instalarea panourilor din policarbonat.

Păstrați aceste instrucțiuni într-un loc sigur pentru utilizări viitoare.

RECOMANDĂRI DE SIGURANȚĂ

Vă recomandăm să folosiți mănuși de lucru în timpul asamblării. Nu încercați să asamblați sera într-o vreme cu vânt sau umedă. Nu atingeți profile din aluminiu ale cablurilor de înaltă tensiune. Purtați întotdeauna pantofi de protecție și ochelari de protecție atunci când lucrați cu aluminiu extrudat. Eliminați toate pungile de plastic în siguranță

- Nu le lăsați la îndemâna copiilor mici. Sera trebuie așezată și montată pe o suprafață plană. În timpul construcției nu vă sprijiniți și nu împingeți sera. Țineți copiii departe de montare.

Nu amplasați sera într-un loc expus vântului excesiv. Nu încercați să construiți această seră dacă sunteți obosit, ați consumat droguri sau alcool sau sunteți predispus la amețeli.

Dacă utilizați o scară sau o unealtă electrică, urmați instrucțiunile de siguranță ale producătorului.

Obiectele fierbinți, precum ar fi grilele folosite recent, arzătoarele etc. nu trebuie depozitate în seră.

Înainte de a introduce materialul, asigurați-vă că nu există țevi sau cabluri ascunse în sol.

RECOMANDĂRI GENERALE

ste un ansamblu format din mai multe piese, a căror montare durează cel puțin 300 de minute. Când selectați o locație, alegeți o locație cu soare în afara ariei de copaci. Dacă puneți sera direct pe o bază solidă de beton, utilizați găurile pre-forate din baza metalică furnizată.

Componentele trebuie verificate și puse, astfel încât să le aveți la îndemână.

Păstrați toate piesele mici (șuruburi etc.) într-un vas, astfel încât să nu se piardă.

Ușa este pusă pe partea dreaptă și de aceea, se deschide spre dreapta. Păstrați acoperișul fără zăpadă și frunze.

ÎNGRIJIRE ȘI ÎNTREȚINERE

acă sera dvs. trebuie curățată, utilizați o soluție de detergent ușoară și spălați-o cu apă curată.

NU UTILIZAȚI acetonă, produse de curățat abrazive sau alte produse de curățat speciale pentru curățarea panourilor transparente.

INSTRUMENTE ȘI ECHIPAMENT NECESAR









Etanșat siliconic, scară metalică și șurubelniță în cruce. Ruletă, ciocan mare și foarfece.









Mănuși de lucru, boloboc, burghiu metalic lubrifianț cu un diametru de 0,08 „Dacă aveți nevoie de ajutor, solicitați ajutor de la un profesionist.

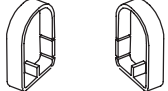



7		1212 mm	4
16-1		1130 mm	1
16-2			1
16-3			1
16-4			1
6		1830 mm	1
5			1
4		1824 mm	2
4-1			2
26		630 mm	4
8		1824 mm	2
8-1			2
17		1824 mm	2
27		630 mm	1
19		1215 mm	10
20		1113 mm	10
10R		1664 mm	1
10L			1
9R		1641	1
9L			1
13		635	1

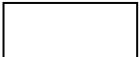

18		1212 mm	1
25		396 mm	1
14		1824 mm	1
12		596 mm	2
22		1362 mm	4
23		1310	2
21		632 mm	2
15		602 mm	5
W1		590 mm	2
W2		522 mm	4
W3		590 mm	2
D1		1614 mm	1
D4			1
D2		621	1
D3			3

PIESĂ	Č.	NUMĂR
	1	2
	2	2
	2-1	2
	3	4
	F3	24
	B2	20

B3		190	
B4		2	
B5		4	
B6		1	
B8		2	
W4		2	
S3		4	
S4		8	
S7		2	

S6L		1	
S6R		1	
F1		10	
F2		1	
F3		1	
F4		139	
F5		3	
F8		2	
F9		2	
S9		2	

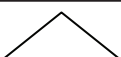
P8		17	
P9		10	
P10		2	
P4L		2	
P4R		2	

P6		1	
P7		1	
P2		2	
P1		3	

Cuplaj pentru bază ->D-4

4 2x	
4-1 2x	
8 2x	
8-1 2x	
26 4x	
17 2x	
27 1x	
F4 24x	

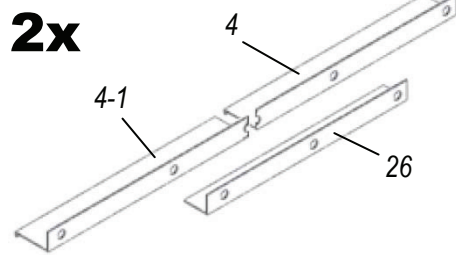



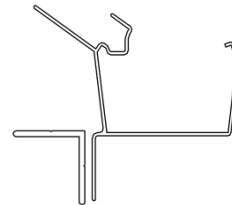
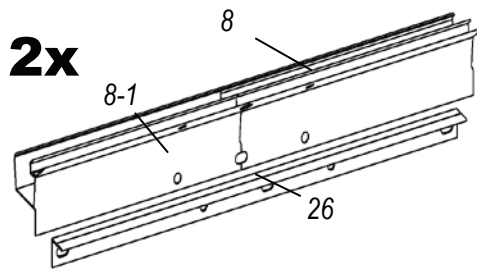

Cuplaj pentru cornișe ->D-8

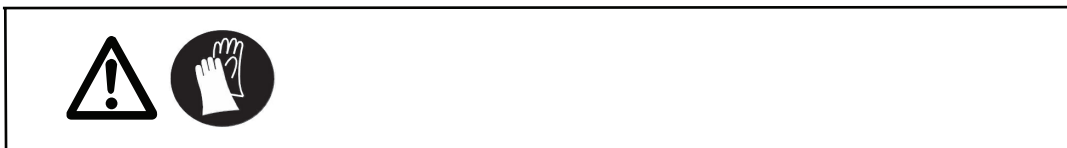
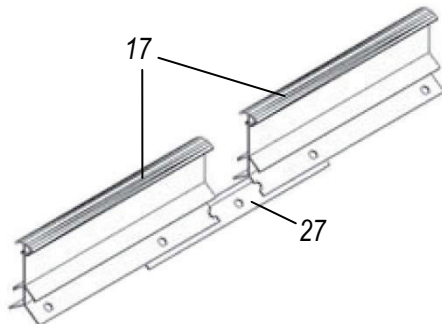







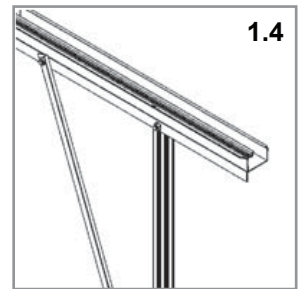
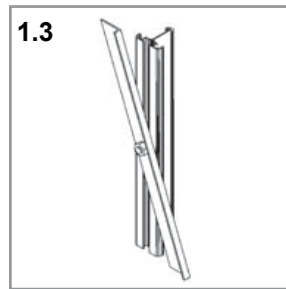
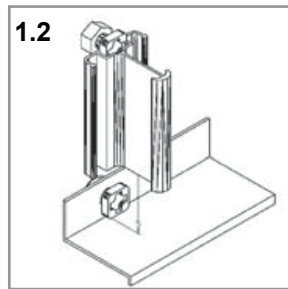
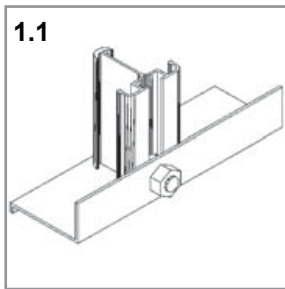
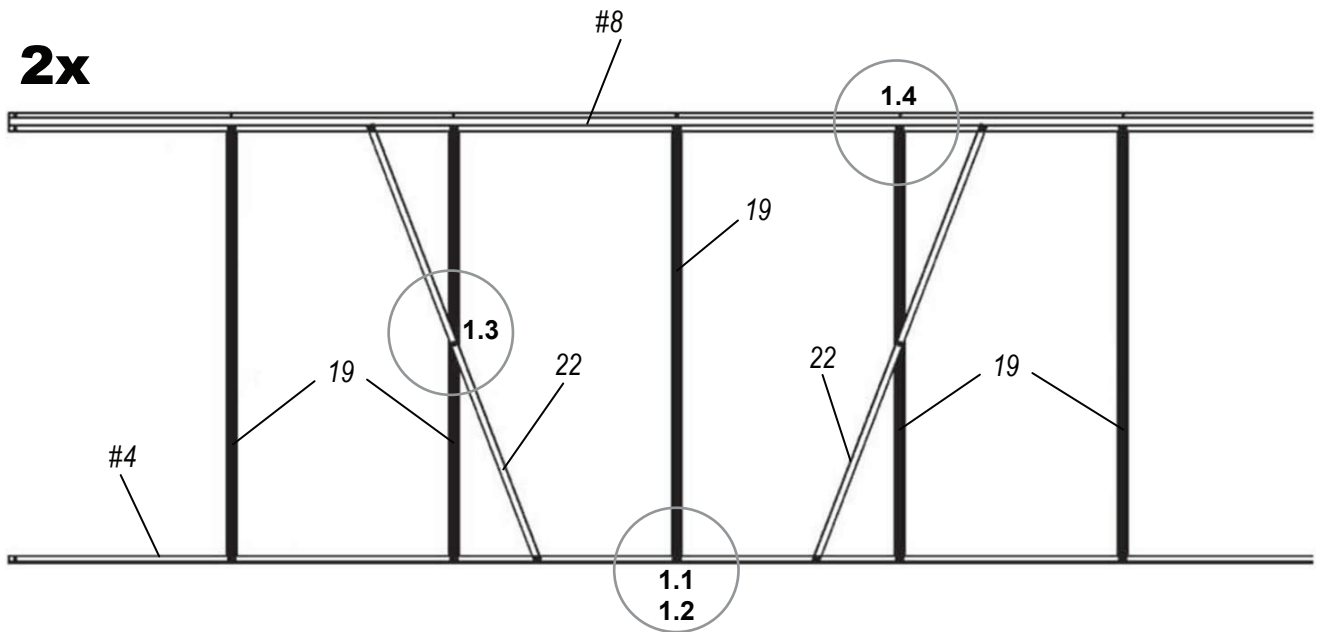

Cuplaj pentru acoperiș ->D-17



#4 2x	
#8 2x	
19 10x	
22 4x	
F4 28x	



7 2x	
16-3 1x	
16-4 1x	
5 1x	
10L 1x	
10R 1x	
14 1x	
B5 2x	
F4 16x	

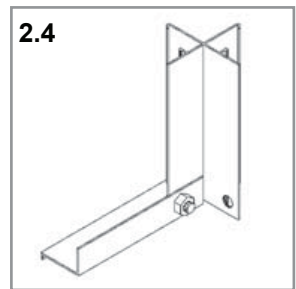
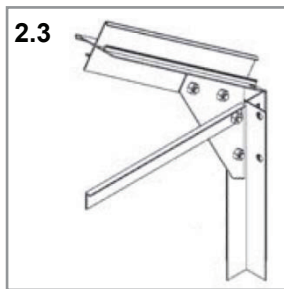
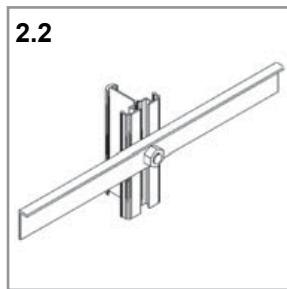
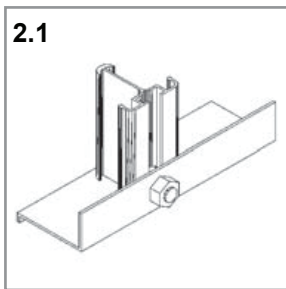
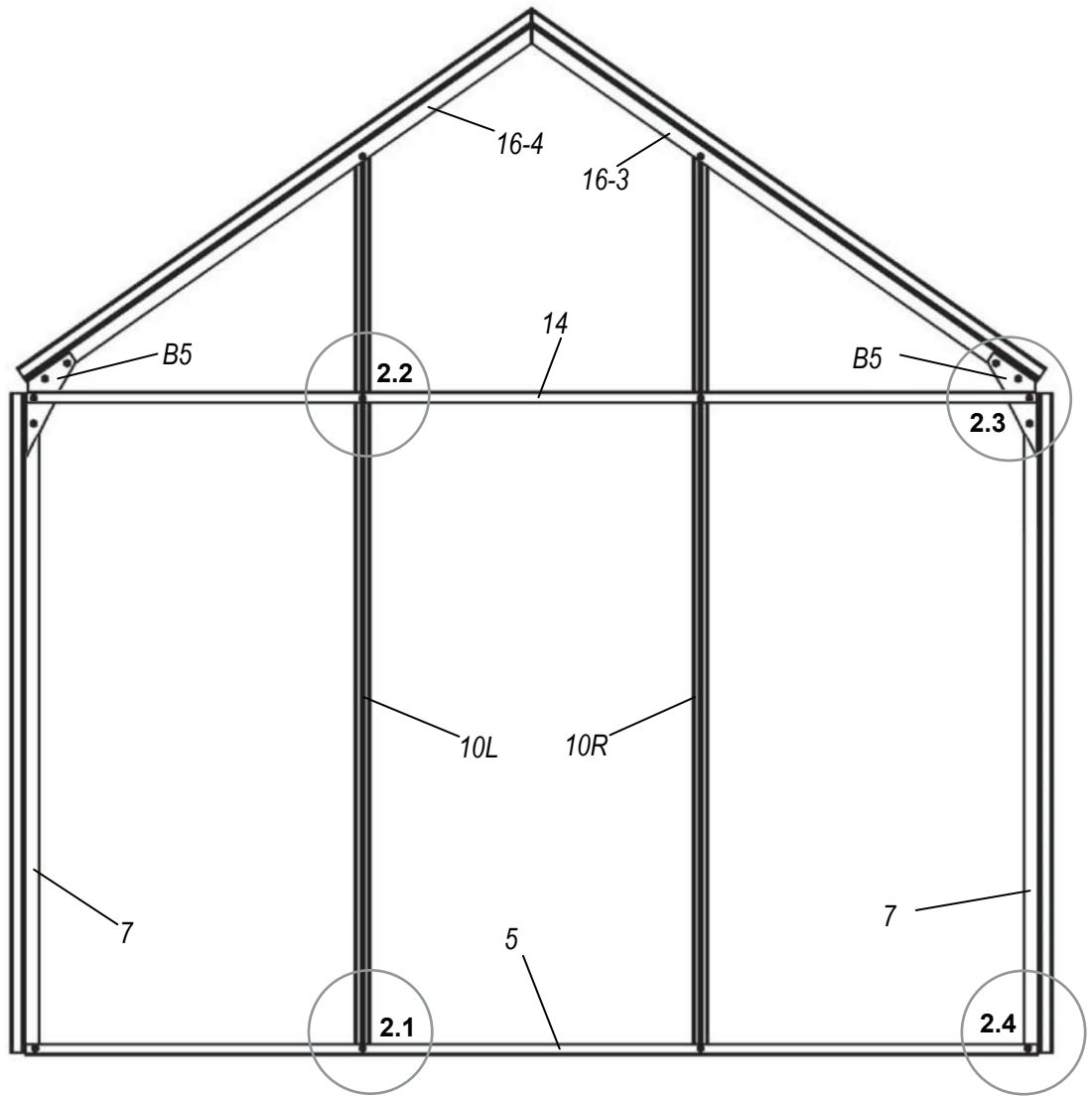

7 2x	
16-1 1x	
16-2 1x	
6 1x	
9R 1x	
9L 1x	
13 1x	
18 1x	
12 2x	
23 2x	
B5 2x	
S6L 1x	
S6R 1x	
F4 18x	
F5 2x	
F2 1x	

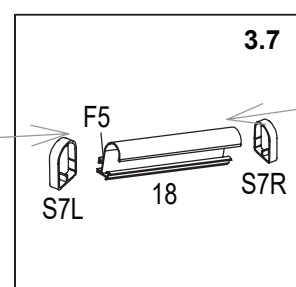
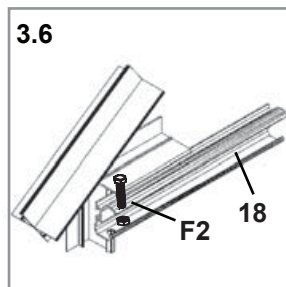
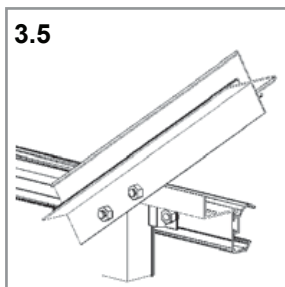
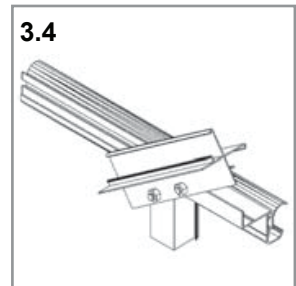
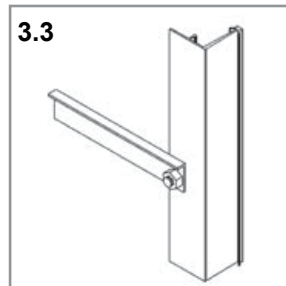
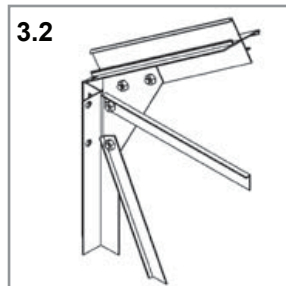
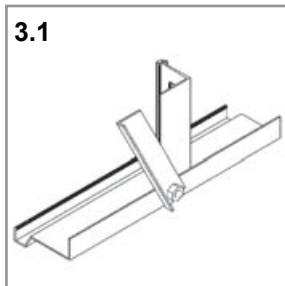
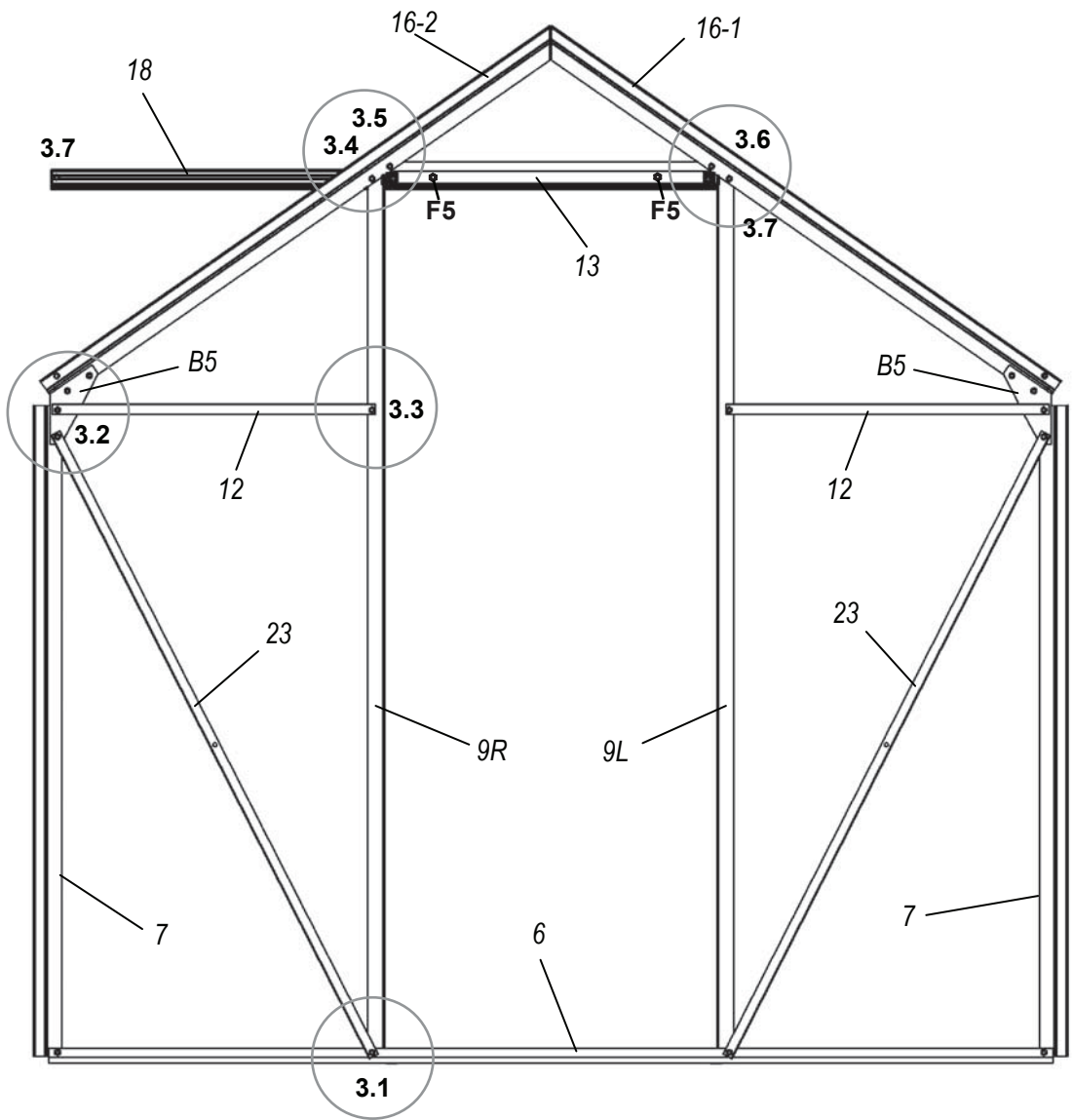



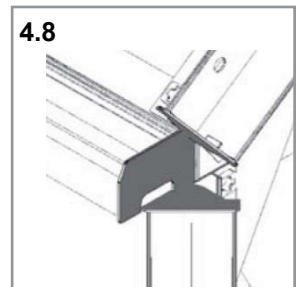
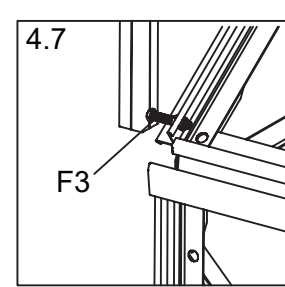
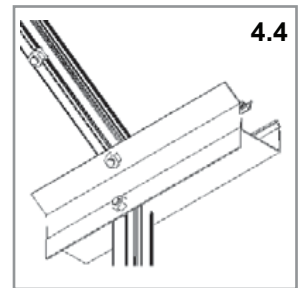
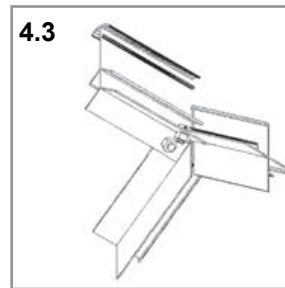
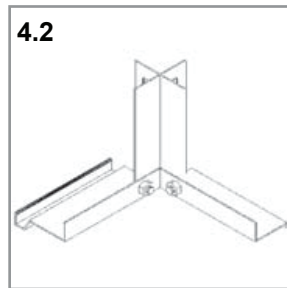
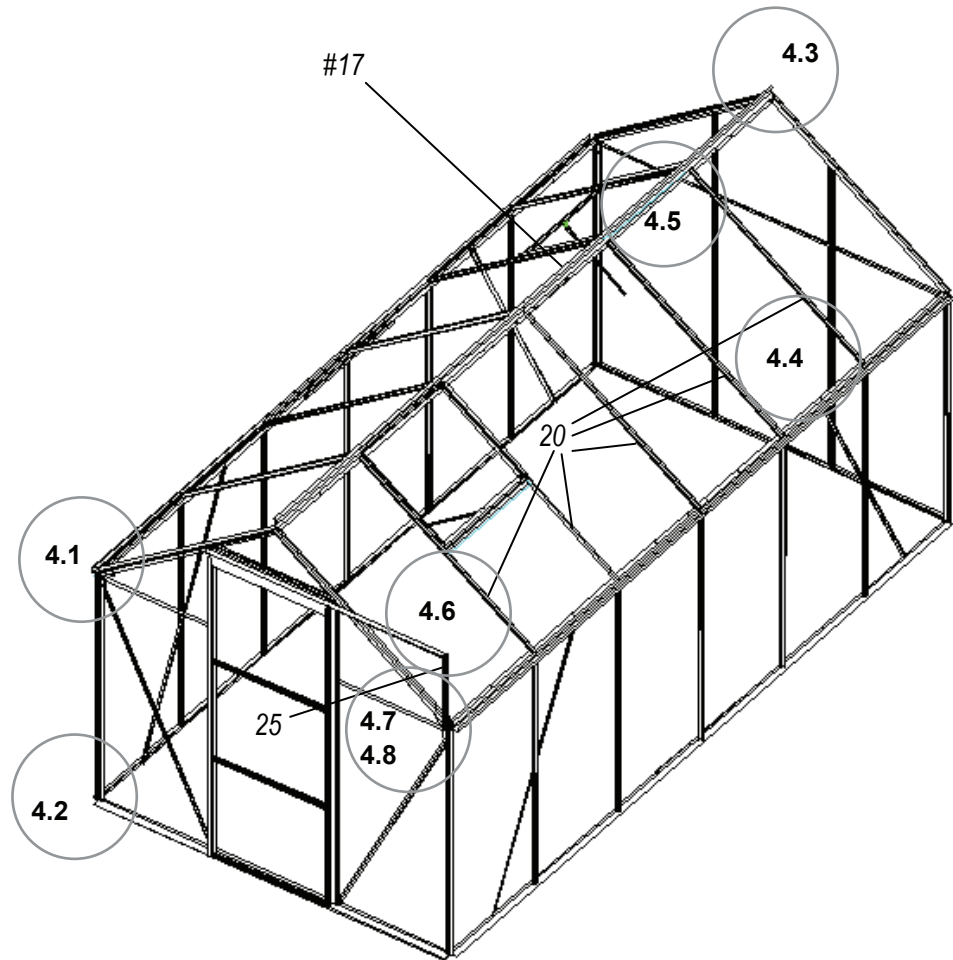



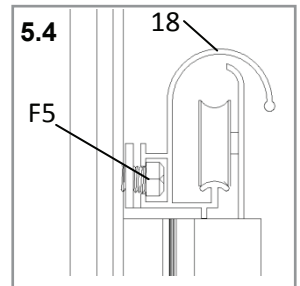
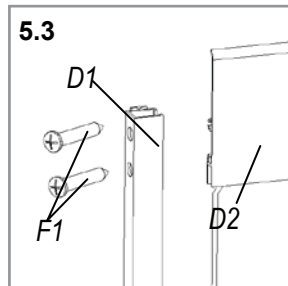
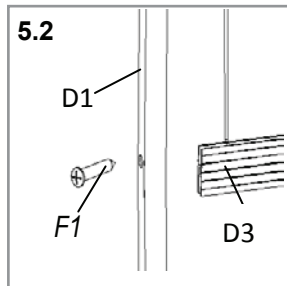
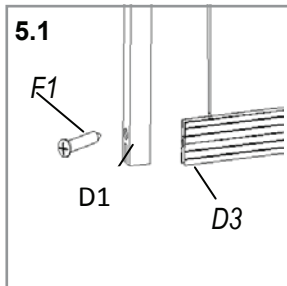
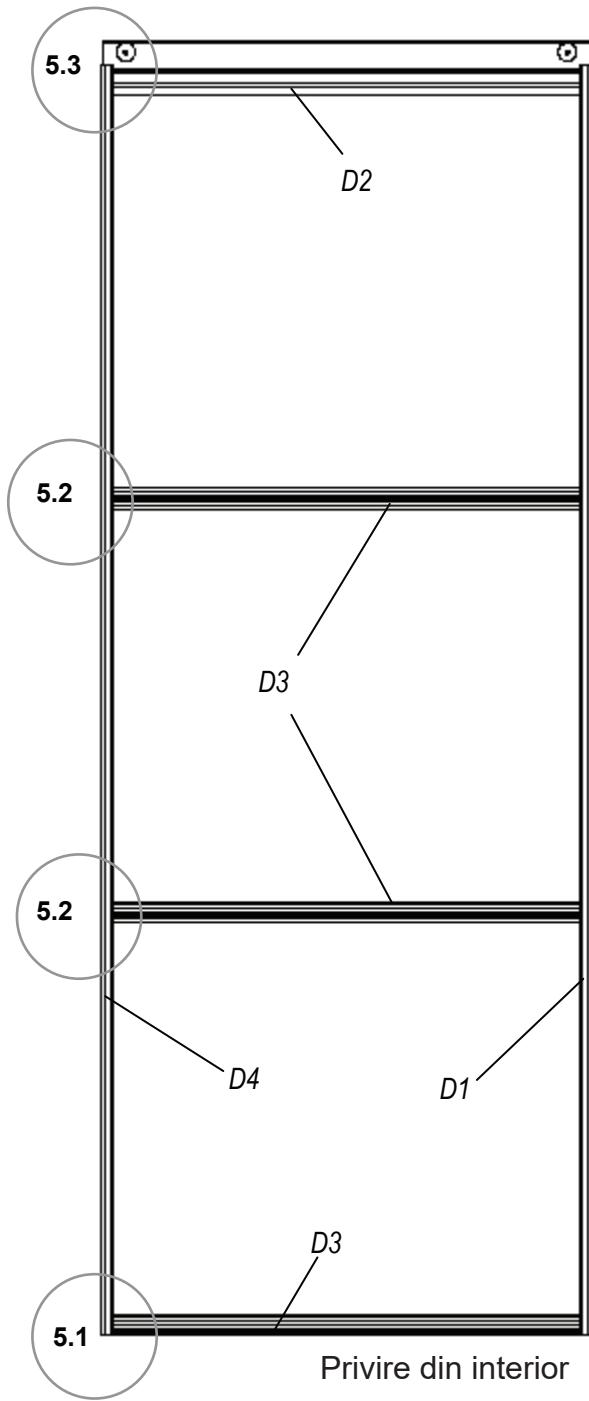





#17 1x	
20 10x	
25 1x	
F3 1x	
F4 37x	
F5 1x	
S3 4x	
S4 8x	



D1 1x	
D4 1x	
D2 1x	
D3 3x	
F1 10x	



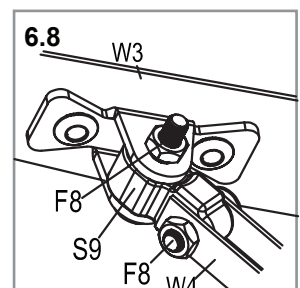
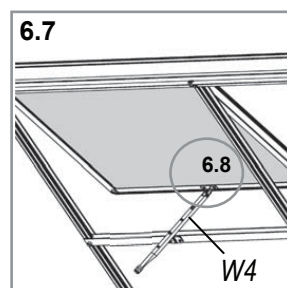
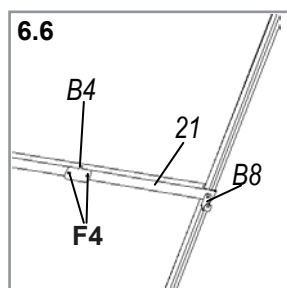
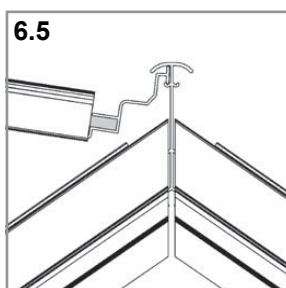
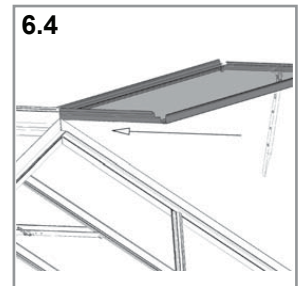
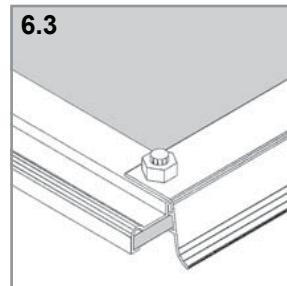
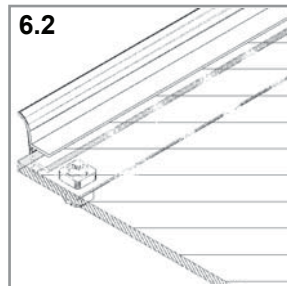
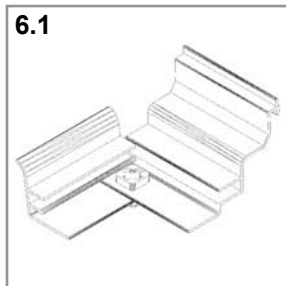
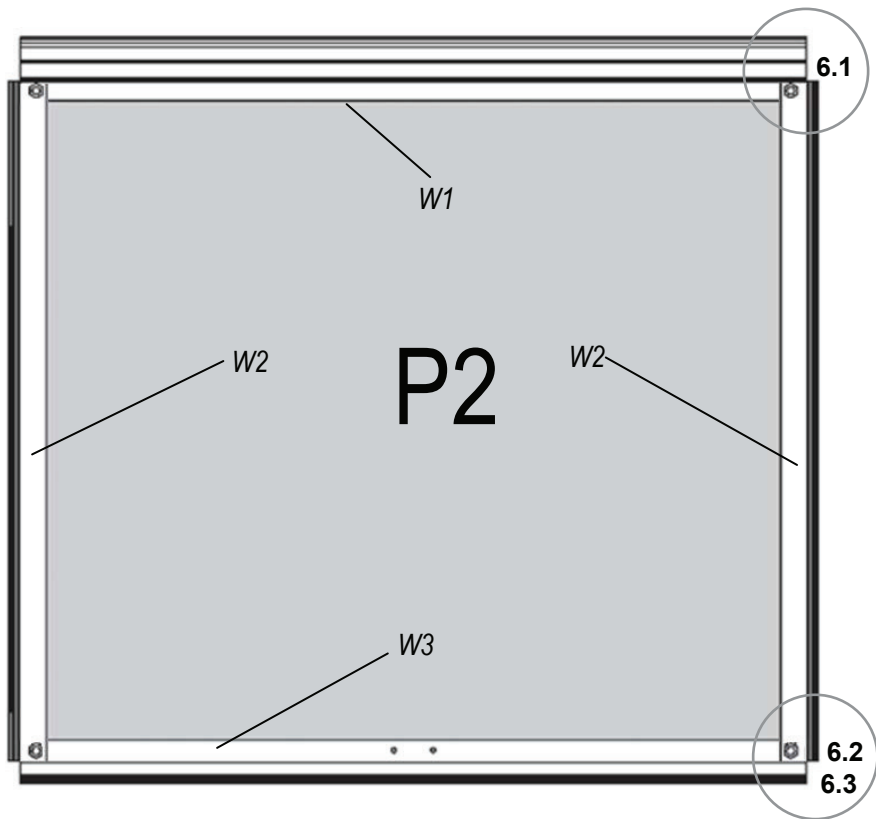

21 2x	
W1 2x	
W2 4x	
W3 2x	
B4 2x	
F4 16x	
S9 2x	
W4 2x	
P2 2x	
B8 2x	
F8 2x	
F9 2x	

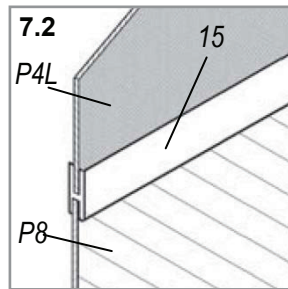
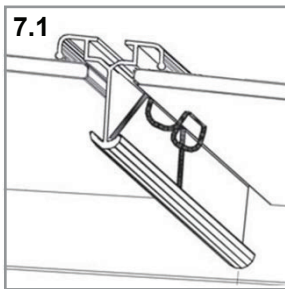
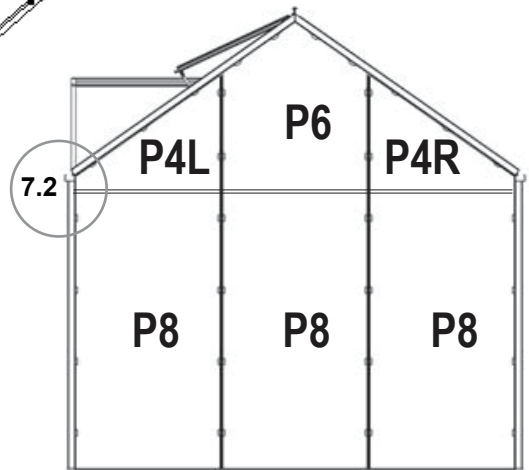
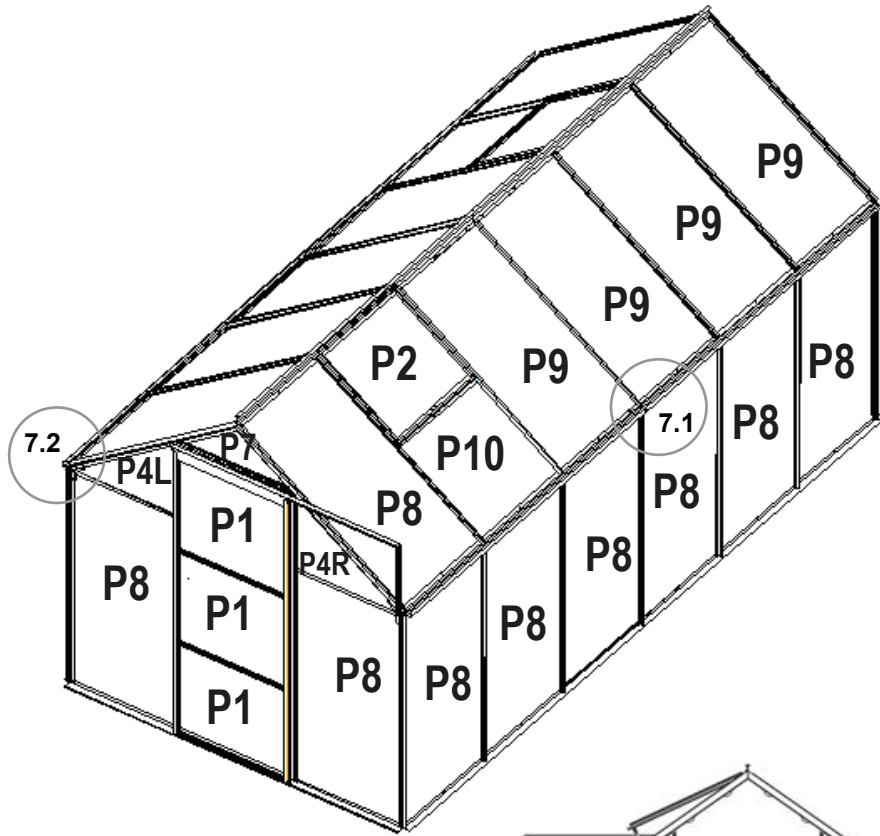

15 5x	
B3 176x	
P8 17x	
P9 10x	
P4L 2x	
P10 2x	
P6 1x	
P7 1x	
P4R 2x	
P1 3x	





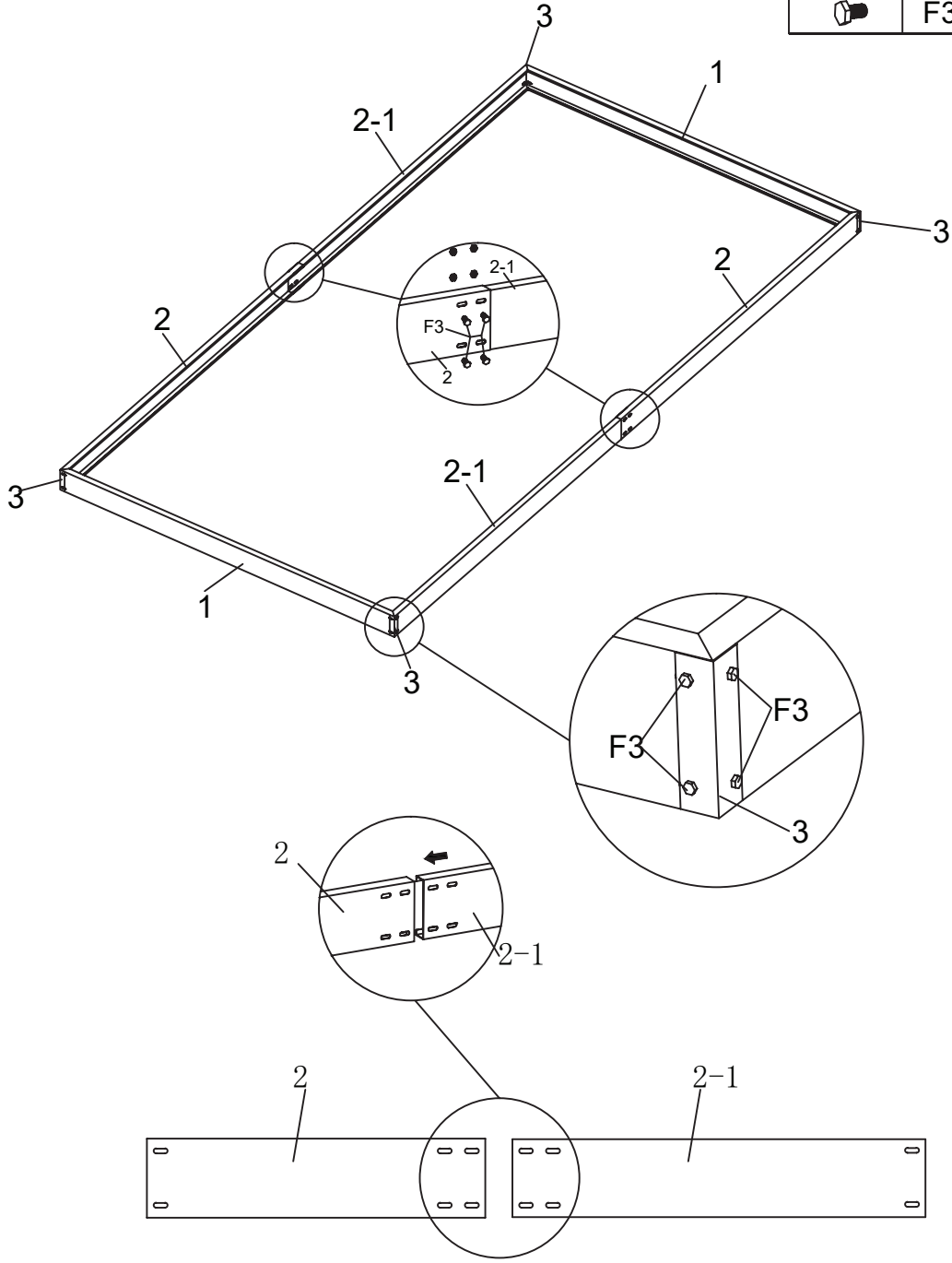

PIESĂ	Č.	Mn.
	1	2
	2	2
	2-1	2
	3	4
	F3	24

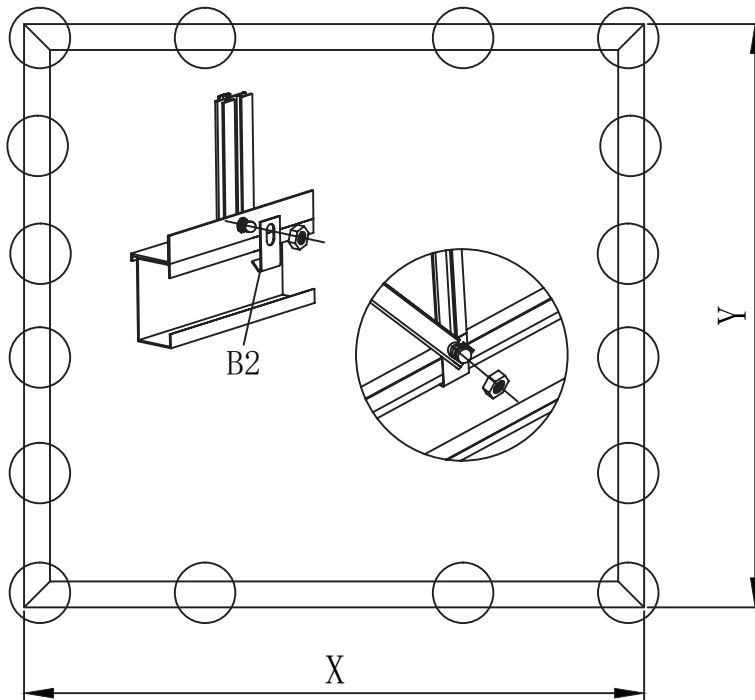
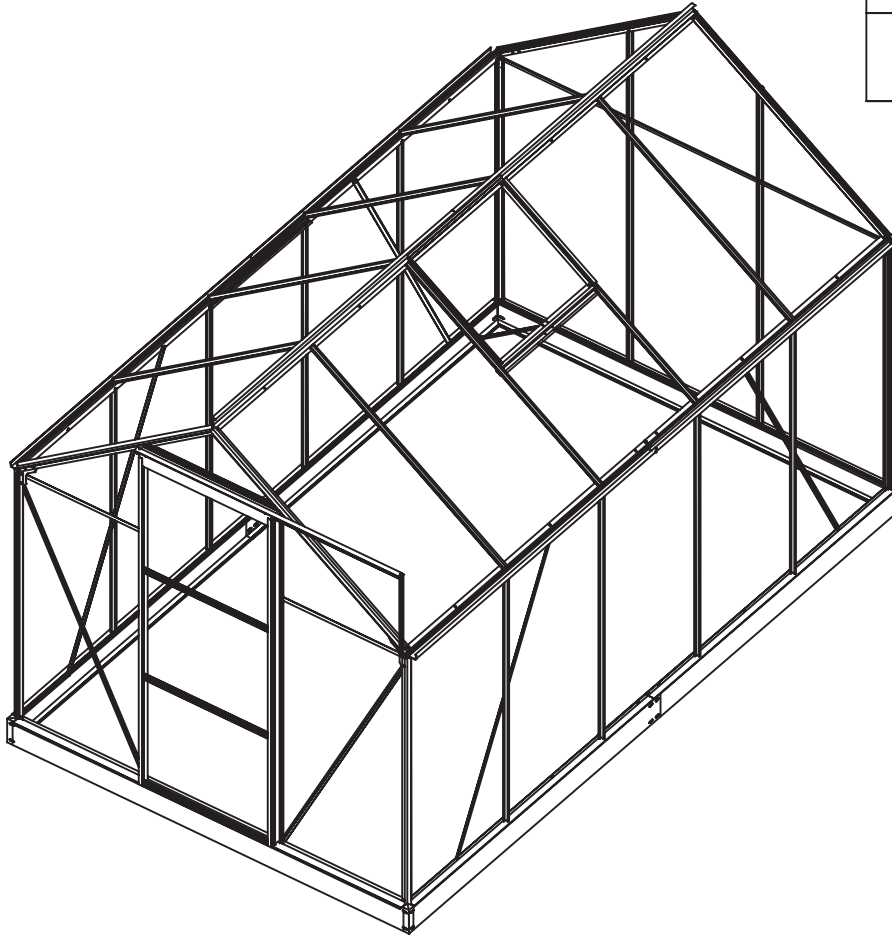

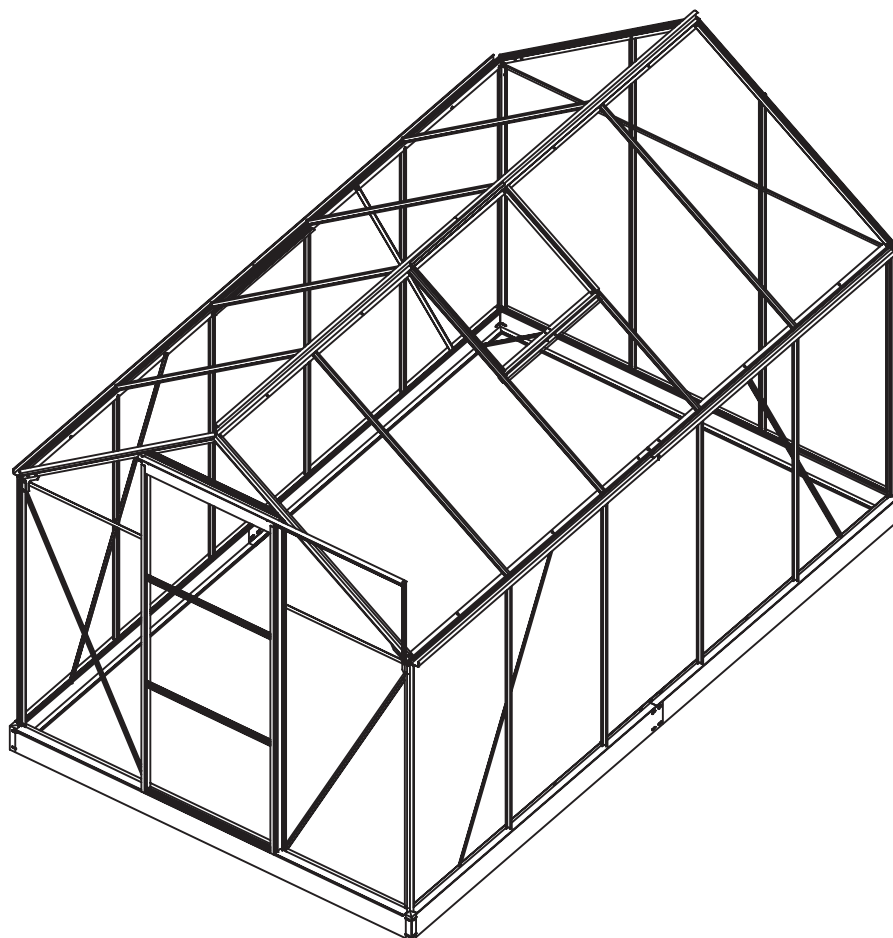
PIESĂ	Č.	Mn.
	B2	20

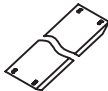



PIESĂ	Č.	Mn.
	1	2
	2	2
	2-1	2
	3	4
	F3	24
	B2	20